

Project:	
Type:	
Catalog #:	



Hazardous/Explosion Proof LED

FME Space-Series

Product Description

The SPACE Series LED Luminaire can be used in locations made hazardous by the presence of flammable vapors, gases, or combustible dusts as defined by the NEC, Atex, CNEX, and CSA. The SPACE Series is NEMA 4X, IP66, and IK10 rated. This Class 1 Division 1 high heat resistant -40°C ~ +65°C, fixture comes **standard with pendant mounting and flat glass lens.**



Shown with glass globe and wire guard



Shown with flat glass lens

Features

- Replaceable Driver & LED's
- 5600 - 14000 Lumens
- Up to 140LPW
- Variable optics
- Dimmable and non-dimmable options available
- Tempered glass lens standard with opal globe and guard option available for wider distribution and protection.
- Various mounting options include: pendant mount, wall mount, stanchion, or surface mount.
- Standard 120-277V, Available options include
 - 277-480V
 - 12-36VDC
- Operating Temperature: -40°C ~ 65°C
- L70 = +150,000 Hours
- **Housing:** A383 Die Cast Aluminum
- **Gasketing:** Fluorosilicone Rubber
- **Hardware:** Stainless Steel 304
- **Finish:** Polyester Powdercoat
- **Lens:** Tempered Glass
- **Expected Life:** Over 85,000 hrs.
- **Rating:** IP66 & IK10
- **Color Rendering Index (CRI):** 70
- **Operating Temp:** -40°C – +65°C
- **Relative Humidity:** 10-90% RH
- **Power Factor:** >.95
- **Input Line Voltage:** 90-305 / 200-525 VAC
- **Input Line Frequency:** 50/60 Hz
- **LED Chips:** Philips
- **Driver:** Meanwell
- **Surge Protection:** 10KV
- **DC Output Ripple & Noise:** <200mVP-P T-Rating | T4

Compliance

UL 844 Hazardous Locations North America

- Class I, Division 1, Groups C, D
- Class I, Division 2, Groups A, B, C, D
- Class II, Division 1, Groups E, F, G
- Class II, Division 2, Groups E, F, G
- Class III

Marking Marine

- UL1598/UL1589A/UL844

Other Markings / Standards

- IP66
- NEMA 4X
- CSA C22.2 No.137/ No.250.0

Applications

- Power Plants / Heavy Industrials Storage Facility
- Paper Mills / Wastewater Treatment Plants
- Loading Docks / Platforms / Shipyards
- Chemical Processing Facility
- Petrochemical Processing Facility
- Mining
- Ocean Marine
- LNG facilities
- Metal Industry

Product Dimensions

Hazardous Location LED Luminaire

Flat Lens w/ Pendant Mount

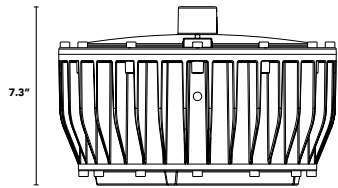

Drop Lens with Wire Guard w/ Pendant Mount

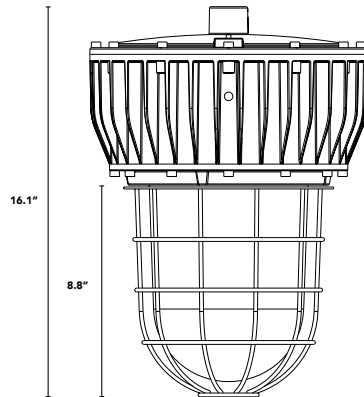

Ceiling Mounting Plate

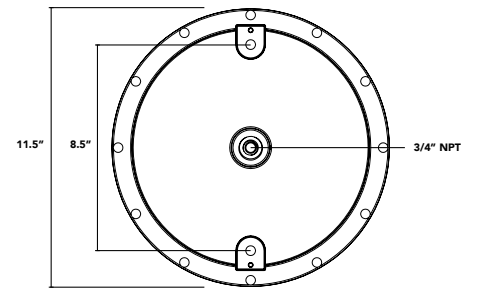

Photometric

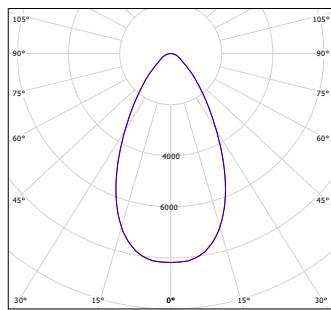

60°

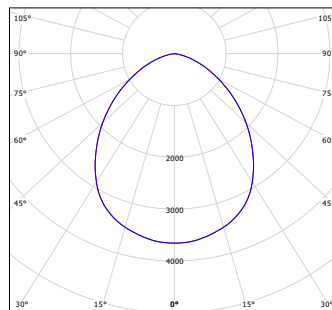

90°

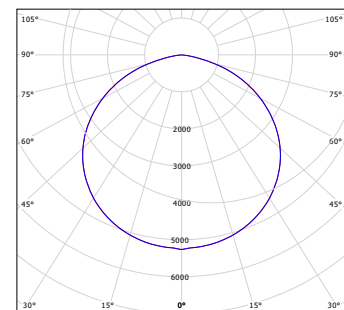

120°

Lumen Chart

	3500K	4000K	5000K	5700K
40W	4,800 lm	5,120 lm	5,400 lm	7,000 lm
60W	7,200 lm	7,680 lm	8,100 lm	8,400 lm
80W	9,600 lm	10,240 lm	10,800 lm	11,200 lm
100W	12,000 lm	12,800 lm	13,500 lm	14,000 lm

Mounting Accessories

Hazardous Location LED Luminaire

OPEB: Junction Box

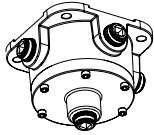

OPWA25: 25° Wall Mount & Junction Box

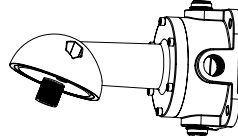

OPWA90: 90° Wall Mount & Junction Box

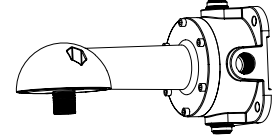

OPWA: 90° Wall Mount

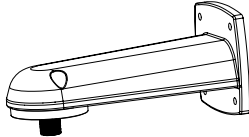

OPPS25: 25° Pole Mount

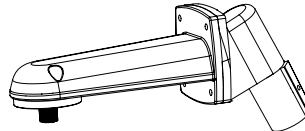

OPPS90: 90° Pole Mount

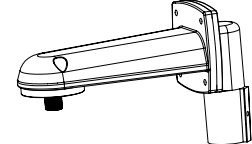

Ordering Information

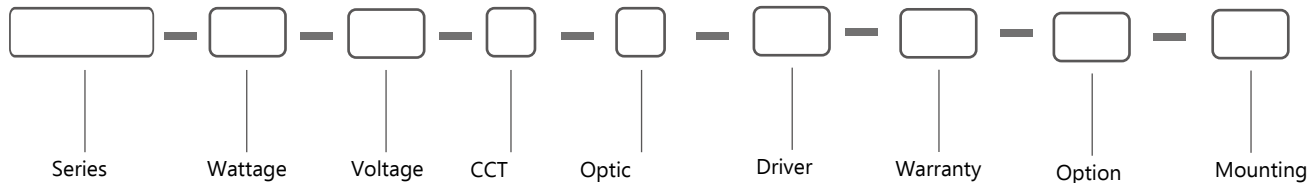

<u>SERIES</u>	<u>WATTAGE</u>	<u>VOLTAGE</u>	<u>COLOR TEMP</u>	<u>OPTIC</u>	<u>DRIVER</u>	<u>WARRANTY</u>
FME-SPA	4 = 40W 6 = 60W 8 = 80W 10 = 100W	A = AC100-277V B = AC200-480V C = 12-48VDC	S = 3000K I = 4000K C = 5000K K = 6000K	N = 60° O = 90° P = 120°	D = 0-10V Dimming ND = No Dimming	5Y = Year Warranty

OPTION

- EM = Emergency Battery Backup
- CG = Clear Globe
- FG = Frosted Globe
- WG = Wire Guard
- CGG = Clear Globe w/ Wire Guard
- FGG = Frosted Globe w/ Wire Guard
- DREF = Dome Reflector
- AREF = Angle Reflector

MOUNTING / ACCESSORIES

- OPEB = Junction Box
- OPCM = Ceiling / Surface Mounting & Junction Box: 3/4" NPT
- OPWA = 90° Wall Mount
- OPWA25 = 25° Wall Mount & Junction Box: 3/4" NPT
- OPWA90 = 90° Wall Mount & Junction Box: 3/4" NPT
- OPPS25 = 25° Pole Mount: 1-1/2" NPT
- OPPS90 = 90° Pole Mount: 1-1/2" NPT